



Installation Instructions

Luxury Vinyl Tile & Plank - Glue Down

Town & Country, Castle & Cottage, El Dorado, Sierra Madre, Hermosa Stone, Times Square



Attention

Before starting installation, read all instructions thoroughly. Should any questions arise, please contact your local Hallmark Floors dealer or phone Hallmark Floors direct at 888 551 0888. Instructions are available at www.hallmarkfloors.com. Instructions are also available via cell phone. All installation instructions must be followed for warranties to be considered valid. Pre-inspect the job site prior to delivery of the floor to ensure the structure is suitable for luxury vinyl flooring installation using the following guidelines

Owner/Installer Responsibility

1. Inspect all materials carefully prior to installation. Warranties do not cover materials with visible defects once they are installed. Installation constitutes acceptance.
2. Inspect the luxury vinyl flooring in well lighted conditions to ensure proper identification of any potential problems. Carefully inspect the flooring for grade, color, finish, and quality. If the flooring is not acceptable, contact Hallmark Floors' distributor and arrange shipment of replacement material. Defective product will be replaced. Material that is subjectively viewed as unacceptable but falls within Hallmark Floors' grading norms will not be replaced.
3. Prior to installation of any flooring, the installer must ensure the job site and sub floor conditions meet the requirements specified in these instructions.
4. Luxury vinyl flooring installation should be one of the last items completed on the construction project. Limit foot traffic on the finished luxury vinyl plank/tile.

Storage & Handling

Handle and unload luxury vinyl flooring with care. Store in a dry place. Make sure to provide at least a 4" space (a dry pallet with a solid plywood top that provides enough clearance under boxes for proper air movement). Prior to delivery of flooring, outside doors and windows must be in place. All concrete, masonry, plastering, and other "wet" work must be complete and thoroughly dry. Roofing and the exterior shell of the structure must be finished and weather tight with doors and windows installed. The wall coverings should be in place and all painting completed—except for the final coat on the base molding. Room temperature and humidity should be consistent with year-round conditions for at least one week prior to installation. When possible, install base molding after floor installation is complete. Flooring should be stored and installed in climate constant or climate controlled indoor location 55°F TO 85°F and between 30 to 50% relative humidity. Product and adhesives must be acclimated to a living condition environment for 48 hours prior to installation.

**ATTENTION: Exposure to sunlight and other heat sources may affect the performance and installation of the floor.*

Pre-Installation Inspection

Visual Inspection

The first inspection is visual and basic. Is there water in the building? Are there uncovered South/West facing windows or sliding glass doors?

Climate Control

If heating and/or air conditioning with proper humidity controls are in operating condition, they need to be turned on. If it is not possible for the permanent system to operate, a temporary system that provides proper temperature and humidity conditions must be in place and remain in place until permanent climate and humidity control is operational. Temperature of 60°-80°F must be maintained.

Install Flooring Last

Luxury vinyl should be the last trade in the house (before base boards are installed). All concrete, masonry, plastering/drywall, texturing, and painting primer coats are completed. Do not install in direct sunlight.

Covering the floor while wet trades are in the house is not recommended. Moisture can pull into the paper or be trapped under the surface of materials used to cover the floor. Paper coverings also allow dents and scratching to occur. Coverings held in place for more than 24 hours by blue tape can damage the floor. The adhesive in tapes contain Phthalates /plasticizers that have the ability to penetrate floor finishes and bond with the finish at the molecular level presenting a risk of pulling/damaging the finish when the tape is removed.

Hallmark Floors recommends that built-in cabinets and built-in furniture be installed before installation of the floor. This prevents damage to the flooring and makes potential flooring repairs simpler to perform.

Exterior Checks

1. Is exterior soil elevation 6" below edge of flashing?
2. Does exterior slope away from foundation at a rate of 6" drop in 10' for soft-landscaped areas and 3" drop in 10' for hard-paved areas?

NOTE: Proper drainage away from the structure is absolutely critical to ensure weather-tight conditions and crucial to proper luxury vinyl flooring performance. If structure is near a hill, the lot should be graded with a swale to move moisture off the lot and prevent it from coming in contact with the foundation.

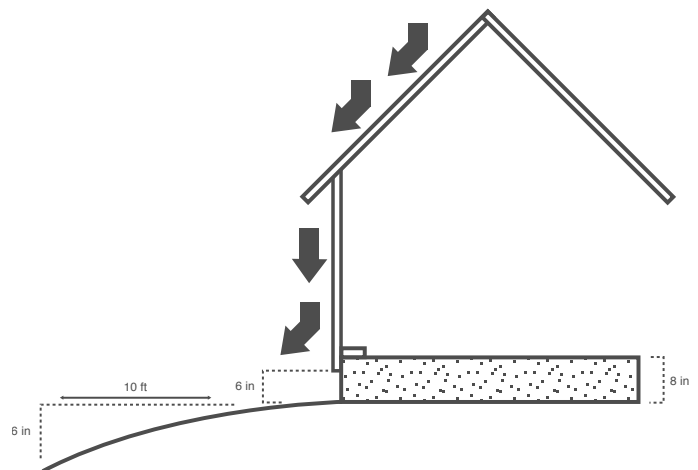

Crawl Space Ventilation

Crawl space earth (or thin concrete slab) should be covered 100% by a vapor retarder of black polyethylene (minimum 6 mil) or any recommended puncture-resistant membrane, such as Class C meeting ASTM D1745. Check local codes for any additional requirements.

Size of available vents should equal to 1.5% of the square footage within the crawl space. Relative humidity should be consistent with interior of home. Moisture content of sub floor should not vary more than a 2% MC from the top of the sub floor to the bottom.

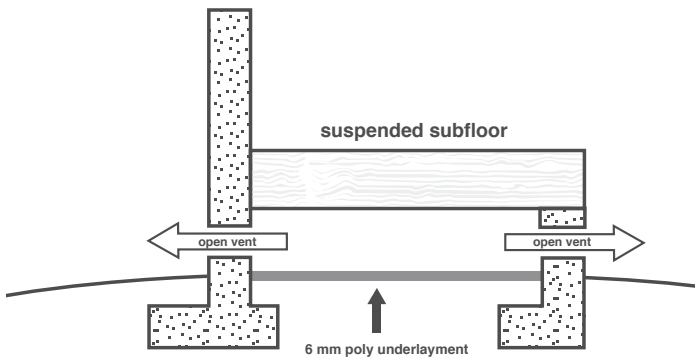

It may be necessary to install temperature/humidity activated exhaust fans to create more air movement in the crawl space. Uncontrolled humidity and moisture in crawl space will lead to mold and damage to the structure, as well as the luxury vinyl floor. In these events, a contractor specializing in dehumidifying systems will need to be contracted to keep crawlspace humidity within proper norms. This is more likely in high humidity areas.

Ensure that clothes driers are properly vented to the outside of the foundation. Check for signs of plumbing, both pressurized and non-pressurized/drain leaks.



NOTE: Completely sealed crawlspaces (no exterior cross-ventilation) require a dehumidification system as part of the sealed crawlspace design.

Basement Moisture & Humidity Control

Basements should be completely weather tight and have proper drainage away from the foundation walls in place to ensure that the basement remains dry.

1. Rain gutters must be in place to carry moisture away from the house. French drains are recommended, and basement walls should be properly sealed.
2. Relative humidity of basements should not be more than 10% higher than the upper floors.
3. Humidity control of the basement is vital to help control mold and prevent damage to the structure and luxury vinyl flooring.
4. Basement walls should be inspected for cracks and excessive moisture content.
5. Drains must be placed at basement windows.
6. Direct sprinklers and irrigation systems away from the foundation. Sprinklers spraying the foundation edge can lead to moisture intrusion into structure. Drip irrigation systems for plant beds is recommended.

Sub floor Moisture Testing CONCRETE

Since Luxury Vinyl and Premium Vinyl flooring is not compatible with wet conditions. The combined, proper application of Hallmark 2 Sealer and Hallmark 3 or 4 adhesive carries specific moisture tolerances for a moisture warranty.

ROLLER APPLICATION: Up to 18 lbs. on a Calcium Chloride Test and up to 97% RH (In-Situ Probe).

HALLMARK #22 TROWEL: Up to 25 lbs. on Calcium Chloride Test and up to 100% RH (In-Situ Probe).

Hallmark Floors does not offer a moisture warranty against moisture related issues or related damage under warranty, unless our system is used. (See Hallmark Floors Maintenance & Warranty Guides).

NOTE: Due to the porous nature of concrete, vapor emissions are subject to change over the lifetime of the installed floor. Slab moisture emissions are a common cause of damage to vinyl floors. Due to the potential for concrete moisture emissions to increase/decrease over time, and the absence of moisture warranties for vinyl flooring, using Hallmark Floors' vapor abatement system, or choosing an alternative adhesive system that includes moisture abatement properties is prudent.

Hallmark Floors' vapor abatement system or alternative adhesive manufacturer's offer moisture warranties for moisture abatement systems that will be conditional. Follow the directions closely to ensure compliance and full warranty coverage. Proper spread rate and coverage are very important. Use proper trowel size and replace trowels at the recommended square footage the adhesive manufacturer requires to ensure proper application thickness.

Some adhesive manufacturers offer adhesive/moisture abatement systems that do not require pre-installation testing of the slab to maintain a moisture warranty. Check with adhesive manufacturer to confirm they offer products that allow installation without pre-checking/testing the slab. *ADDITIONAL NOTE: Hallmark Floors makes no guarantees regarding the performance of any adhesive/vapor abatement system other than our own.*

The installer is fully responsible for proper installation, and the moisture warranties are fully the responsibility of the adhesive moisture abatement system manufacturer chosen for the job.

Industry Standards

Industry standards use the following test methods to determine optimal conditions for installation and performance of a hardwood floor. Some adhesive manufacturers offer systems that create a vapor barrier to protect the luxury vinyl and premium vinyl flooring from moisture emissions coming up through the slab. Many adhesive manufacturers require the below listed tests to be performed prior to installation of the floor: *Carefully read and follow the adhesive manufacturers instructions.*

CALCIUM CHLORIDE: ASTM F1869

Under ideal conditions, the slab should not be emitting more than 3 lbs. per 1,000 square feet per 24 hour period. Carefully follow the instructions in the test kit to ensure that you get accurate results.

NOTE: The slab emissions can vary based on soil humidity and room temperature. Consult adhesive manufacturer's directions for the moisture abatement system they recommend.

HUMIDITY PROBE & DIGITAL METER: ASTM F2170

Widely used in Europe, this test determines the amount of humidity in the slab. This is an effective way to determine a slab's potential for emitting moisture. Follow all meter manufacturer's guidelines for performing testing. Under ideal conditions, the slab readings should be 75% RH.

CAUTION: Post Tension slabs require special care to avoid cutting cables in slab. Cutting post tension cables can cause serious structural damage and potential fatalities.

New concrete slabs require a minimum of 60 days drying time before covering them with a luxury vinyl or premium vinyl floor. The slab must be fully cured. Slab must be comprised of Portland-based mix with 2,500 PSI of compressive strength.

Sub floor Preparation CONCRETE

For glue down application over gypsum or lightweight concrete, the same 2,500 PSI rating is required.

Note: Some adhesive systems have primers and adhesives that are suitable for use over gypcrete or lightweight concrete, and may have different PSI compressive strength requirements. Adhesive manufacturer is responsible for performance of their systems over gypcrete or lightweight concrete.

Remove all paint, oil, existing adhesives, wax, grease, dirt, sealers, and curing compounds. Do not use solvent-based strippers under any circumstances because residual solvents can prevent the satisfactory bonding of the vapor barrier and adhesive systems. It is important to ensure a long lasting bond between the adhesive, the concrete, and the boards.

All sub floors must be clean, smooth, and flat within 3/16" in a 10' radius or 1/8" within a 6' radius. Dust, scale, old adhesive, and asphalt cut-back adhesive must be removed.

CAUTION: Test cut-back adhesives for asbestos content. If the cut-back contains asbestos, contact an asbestos abatement company for professional removal.

The surface must be free of paint, grease, drywall, curing/sealing compounds, existing resilient floors, engineered hardwood floors, wax, oil, alkali and any other foreign material that would negatively affect the bonding of the adhesive.

Use sanding system with 20 grit # 3-1/2 open-face paper to remove loose, flaky concrete. For heavy surface contamination, it may be necessary to bead-blast the concrete surface.

Sub floor tolerance for a flat surface is 3/16" within a 10' radius and 1/8" in a 6' radius. These are widely accepted industry standards. Use a straight edge to determine if sub floor requires grinding or filling.

Surface of the concrete floor should be similar to light broom finished concrete before proceeding with installation.

All sub floor patching and leveling should be done with a quality, water resistant, non-shrinking Portland cement patch. Concrete floor must be smooth and flat to prevent telegraphing imperfections in the concrete. NOTE: Be sure to use Portland based patch and levelers on Portland based slabs and Gypsum for Gypcrete. Follow all manufacturer's guidelines for those products.

Wear appropriate NIOSH designated dust mask to reduce risk of dust inhalation. Wear proper eye protection and avoid prolonged contact with eyes and skin. In the event of eye irritation flush with water for 15 minutes and seek medical attention!

Hallmark Floors is not responsible for any movement in expansion joints in concrete slab, nor any performance issues related to the sub floor.

CAUTION: ASBESTOS

State and Federal agencies have determined that asbestos is a respiratory carcinogen. Avoid sanding or scraping of old vinyl, linoleum, and VCT as they may contain asbestos. Take proper precautions and contact an asbestos abatement company to remove any old vinyl or vinyl tile floors containing asbestos. Cut-Back adhesive and other types of adhesives can also contain asbestos.

Do not sand, sweep, dry or wet scrape, mechanically chip, bead blast, or pulverize existing resilient flooring, the felt, lining, paint, black asphalt cutback adhesives, or other existing adhesives. These products could contain asbestos fibers or crystalline silica.

Breathing dust from these sources increases your risk of cancer and respiratory diseases. If you smoke and are exposed to asbestos fibers, you are at greater risk of serious damage to your health.

If you are not sure that the product being removed is asbestos free, assume that the product contains asbestos or crystalline silica. Regulations in your area may require you to have the material tested to determine if it contains asbestos. Check the Resilient Floor Coverings Institutes' recommendations for removal of existing resilient floor coverings.

Chemical adhesive removal products must not be used to prepare the slab. Use of such chemicals will void the warranty on all Hallmark Floors products

Installing over Existing Floor Coverings on Concrete

Perimeter-glued resilient vinyl, VCT and rubber tiles are not acceptable underlayments and must be removed.

Sub floor Moisture Testing wood

Probe-type (pin) meters are considered the best method of testing.

Remember: the top and bottom of the sub floor should vary no more than 2%. Wood substrates must have a moisture reading of no more than 12% when using Lignomat, Tramax, Delmhorst, or equivalent moisture meter, and be within 4% of the moisture content of the flooring to be installed

Sub floor Preparation wood

1. Wood sub floors with a crawlspace must have a minimum of 18" between the bottom of the joists and the surface of the soil. Soil must be covered with 6-8 mil black plastic as vapor barrier. Plastic must be overlapped at joints by a minimum of 8 inches and fully taped with a high quality moisture-proof duct tape.
2. All sub floors must be clean, smooth and flat within 3/16" in a 10' radius and 18" in a 6' radius. Dust, scale, old adhesive, and asphalt cut-back adhesive must be removed. The surface must be free of paint, grease, drywall, curing/sealing compounds, existing resilient floors, engineered hardwood floors, wax, oil, alkali, and any other foreign material that would negatively affect the bonding of the adhesive.

CAUTION: Test cut-back adhesives for asbestos content. If the cut-back contains asbestos, contact an asbestos abatement company for professional removal.

3. Solid Board Sub flooring should be 3/4" x 5 1/2" (1" x 6") group 1 dense softwoods (SYP, Doug Fir, Larch, etc.), #2 common, kiln-dried. Solid board sub flooring should consist of boards no wider than 6", installed on a 45° angle, with all boards ends full bearing on the joists and fastened with a minimum 8d rosin-coated or ring-shanked nails, or equivalent. Solid board sub flooring that is uneven at edges should be repaired and sheeted with 1/2" (15/32", 14 mm) Baltic Birch 1 plywood sub floor panels, 4' x 8' sheets, and should be installed running cross-truss/joist. Glue top and bottom layer together with construction adhesive and screw into the truss/joist system every 12". Additionally nail (ring shank) or staple layers together on a minimum 12" grid pattern.

4. Plywood/OSB Sub floors

- a. Truss/joist spacing of 16" (406cm) o/c or less, the industry standard for single panel sub flooring is a minimum of 5/8" (19/32", 15.1mm) CD Exposure 1 plywood sub floor panels or 23/32" OSB Exposure 1 sub floor panels, 4' x 8' panels. Place 6-9mm Baltic Birch plywood on surface.
- b. Truss/joist spacing of more than 16", up to 19.2" (488mm) o/c, the standard is a minimum 3/4" (23/32", 18.3mm) tongue and groove CD Exposure 1 plywood 4' x 8' sheets glued and mechanically fastened. Place 6-9mm Baltic Birch plywood on surface.
- c. Truss/joist spacing of more than 19.2" (488mm) o/c up to a maximum of 24" (610mm) o/c requires a minimum 7/8" tongue and groove CD Exposure 1 plywood sub floor panels, 4' x 8' sheets, glued and mechanically fastened, or nominal 1" OSB Exposure 1 sub floor panels glued and mechanically fastened—or two layers of sub flooring. Place 6-9mm Baltic Birch plywood on surface.

5. Joist Cross-Bracing

A sub floor that is not thick enough to support the span of the joists will cause unacceptable sub floor deflection. An alternative to adding additional plywood on top of the sub floor would be to cross-brace between the joists. The cross-bracing would be done at the appropriate distance on center to meet specification and bring the deflection within proper tolerance.

Check with the joist or truss manufacturer to determine if cross-bracing is allowed with that system. Should it not be compatible with the joist or truss manufacturer, sheeting the sub floor with a second layer of 9mm/ 3/8" Baltic Birch plywood would then be the only option.

DIRECTION OF INSTALLATION IN RELATION TO JOIST DIRECTION.

The best application is at a 90° angle across the joists. This provides for best stability of the floor. As an alternative, the floor can be installed at a 45° angle to the joists. The floor cannot be installed in the same direction as the joists without installing an additional sheet of plywood on top of the existing wood sub floor.

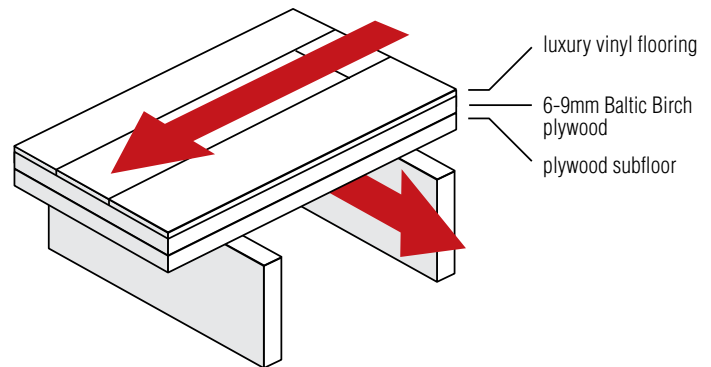

6. For Glue Down Application Sheet wood sub floor with minimum 6mm Baltic Birch Underlayment Plywood. Use 9mm if sub floor needs additional rigidity.

Hallmark Floors does not warrant our products glued down to subfloor-grade plywood, particle board, O.S.B, Luan or Maranti types of underlayment.

NOTE: Hallmark Floors' adhesives will adhere to sub floor grade plywood and to OSB, however the amount of movement in these products will affect the flooring, and telegraphing issues commonly occur with this type of installation.

6mm Plywood Underlayment Crossection

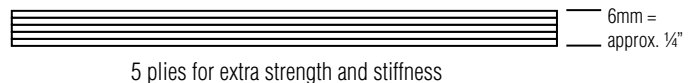

9mm Plywood Underlayment Crossection

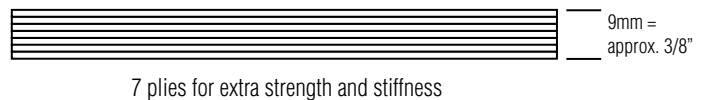

7. Make any repairs necessary to the existing sub floor prior to installing Baltic Birch plywood underlayment.

CAUTION: Some nail types, i.e. common steel nails, can cause discoloration of the vinyl floor. Gluing down with construction adhesive and screwing plywood panels into joists can cause discoloration issues. Solvent-based construction adhesives can stain vinyl floor covering. Use of solvent free construction adhesives is therefore recommended to avoid floor stain issues.

Hallmark Floors, is not responsible for discoloration of vinyl floor from adhesives used to secure Baltic Birch plywood underlayment to sub floor.

8. See Baltic Birch plywood underlayment manufacturer's specification/ instructions for proper installation of product.
9. Stagger Baltic Birch plywood end joints and loosely butt edges per installation panel manufacturers installation instructions. Fastener holes and seams should be filled with a polymer modified patch such as Ardex Feather Finish or Mapei Fine Finish. These products are applied in a thin skim coat per manufacturers instructions. Make sure to fill all end and side joint nail holes and dents in the underlayment to prevent transfer to the surface. Allow to dry completely.

Note: Remember, the patch may be 1/4" deep or more in the joint between two panel edges. Not that it will not dry as quickly as a surface patch. When a latex adhesive is applied to the underlayment, some of the water is absorbed into the wood causing it to expand slightly. This expansion will force the wet patch out of the joint, forming a bead that can be seen through the vinyl.

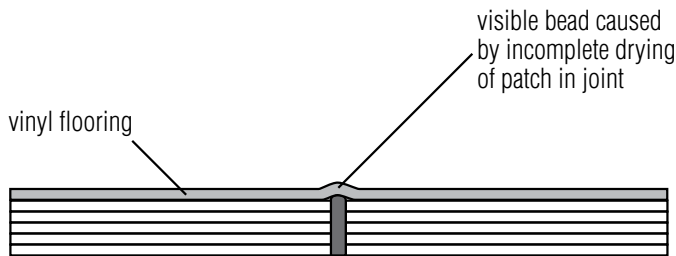

10. Lightly butt Baltic Birch plywood underlayment panel edges together. Do not force panels together, but do not leave a gap. Leave a minimum perimeter gap of 1/4" and a maximum gap of 1/2" between the Baltic Birch plywood underlayment panel edges and the walls for expansion.
11. Cut Baltic Birch plywood underlayment panels as necessary and lay out factory edges to factory edges. Lay out any edges with jobsite cuts towards the wall. Make any long, straight cuts from the underside of the Baltic Birch plywood underlayment panel using a circular power saw with a fine toothed blade. Adjust the blade to extend no more than 3/8" through the Baltic Birch plywood underlayment to minimize splintering.
12. Selecting the Baltic Birch plywood underlayment fasteners: Use plated ring shank underlayment nails with a 3/16" diameter head or double coated chisel point staples with a 1/4" maximum crown. The fastener length should be selected so that the point will not extend through the bottom side of the sub floor. Do not use uncoated, cement coated, or rosin coated fasteners, as they may contribute to staining/discoloration. Ensure the panel is in firm contact with the sub floor. Always have your body weight on the panel being fastened.

NAIL HEAD SLIGHTLY COUNTERSUNK

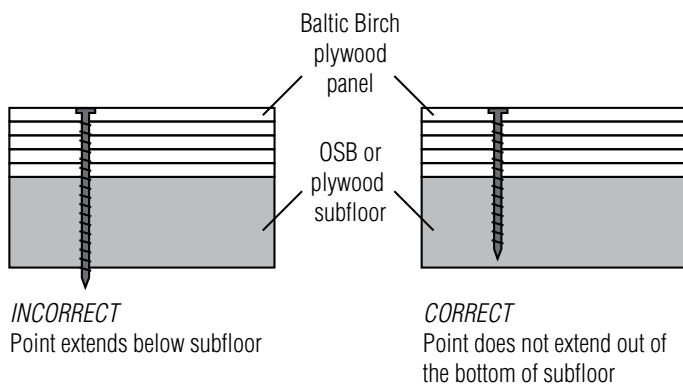

13. All fasteners should be countersunk slightly below the surface of the new underlayment. Adjust air pressure on air staplers to a minimum to avoid staple blow through. Fill with feather patch approved for such use, allow to dry, and sand nail holes and joints to prevent telegraphing through surface of vinyl. Avoid over-sanding and cupping of joints.
14. Once the patch is dry, re-sand all areas with a low-speed rotary sander. If necessary, patch again, allow to dry, and re-sand with a low-speed rotary sander. Proceed with the installation according to Hallmark Floors' and adhesive manufacturer's instructions. Keep the underlayment clean and dry until luxury the vinyl flooring is ready to be installed. If necessary, cover Baltic Birch plywood underlayment with protective paper until ready to install luxury vinyl flooring.

Clean the Sub floor

After all prep work is completed, sweep and/or vacuum the sub floor. Dust and dirt can affect the adhesive's ability to adhere to the sub floor.



Other Substrates QUARRY TILE, TERRAZZO AND CERAMIC TILE.

Any embossing or grout joints need to be filled with a Portland-based cementitious patch. Substrates must be firmly attached to sub floor. Hallmark Floors makes no warranties in regards to performance or suitability of use of any sub floor or substrate.

The surface must be sound, tight, and free of paint, oil, existing adhesives, wax, grease, and dirt.

Terrazzo and ceramic tile must be sufficiently scuffed to assure adhesion. Portland based cementitious levelers must be used to comply with flatness requirements of 3/16" in a 10' radius or 1/8" in a 6' radius. See adhesive/ cementitious levelers manufacturer's guidelines.

Existing vinyl, tile, or terrazzo are not considered to be vapor barriers and can still transmit unacceptable moisture levels which can become trapped under a vinyl floor. This is true of both concrete and wood sub floors. Wood fibers, dust, drywall, latex paint, or other organic material under the floor can promote fungal growth, degradation of adhesives, and dimensional instability in the plank/tile. Therefore, preventing excessive moisture under the floor is critical.

Existing hardwood flooring must be remove prior to installation.

Luxury Vinyl Radiant Heat

All Radiant Heat systems must have failsafe capability to ensure surface temperatures do not exceed 80°F.

Lightweight Concrete/Gypcrete

1. The heating system tubes must be 1 ½" below the surface layer of the concrete slab/thermal mass.
2. 2–3 weeks prior to the installation the thermostat must be set at 70° F, then at 85°F for 3 days. The home should be aired out briefly every day to allow the excess humidity from the thermal mass to exhaust out of the structure.
3. The lightweight concrete moisture content must not exceed 1.5% as measured with a Tramax Moisture Encounter meter prior to installation. Use of Hallmark 1 (in conjunction with Hallmark 3 adhesive) when applied, per instructions, will enable the floor to be glued down to gypcrete.
4. Lightweight concrete/gypsum based thermal mass must have a minimum compressive strength of 2,500 psi. If gluing down with product other than Hallmark 1 Primer and Hallmark 3 Adhesive, see adhesive manufacturer's recommendations for compressive strength.

Wood Sub floor Systems With Aluminum Transfer Components

5. **ALUMINUM HANGERS**
Aluminum hangers must be .03125"/0.79mm to .0625"/1.58mm thick and have a minimum of ¾" sub floor. Hangers must reach joist to joist 16" to 19.2" on center, and have no gaps between sides and ends of aluminum hangers. A good system also contains insulation to prevent thermal loss and ensure even heating.
6. **DECKING OVER SLEEPERS**
Decking must be a minimum of ¾" thick with a minimum ¾" sub floor with an aluminum transfer sheet of .03125"/0.79mm to .0625"/1.58mm in thickness and attached to the bottom of the decking material. Sleepers should be 18" on center. In-floor heating systems must be water-based, low temperature, and must be designed to prevent surface temperature of the floor from exceeding 80° F. All glue down applications on wood sub floor assemblies must be sheathed with at least 6mm Baltic Birch plywood and prepped as described in these instructions.
7. *No electric radiant heat systems are approved for use with Hallmark Floors luxury vinyl flooring!!!*
8. Passive radiant heat systems are not suitable for use with Hallmark Floors luxury vinyl flooring. Any approved radiant system must be combined with the ability to move the air in the room for proper heat distribution and to prevent excessive heat at floor level. Humidity controls must be in place to maintain relative humidity within a 30 to 55% RH range.

9. Surface-channeled radiant boards, are not acceptable for use under Hallmark Floors luxury vinyl flooring. A minimum of ¾" must be maintained between the vinyl floor and the water tubing. This is not possible with these types of systems. This applies to systems with or without an aluminum transfer sheet.

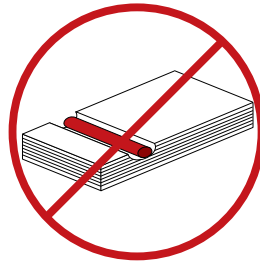

Sub floor level tolerances listed previously, also apply to radiant heated sub floors.

NOTE: Area rugs placed over radiant heat slab will create heat retention in the floor. This may result in that area exceeding optimum temperature, and causing slightly larger gaps and minor distortions to the floor under the rugs.

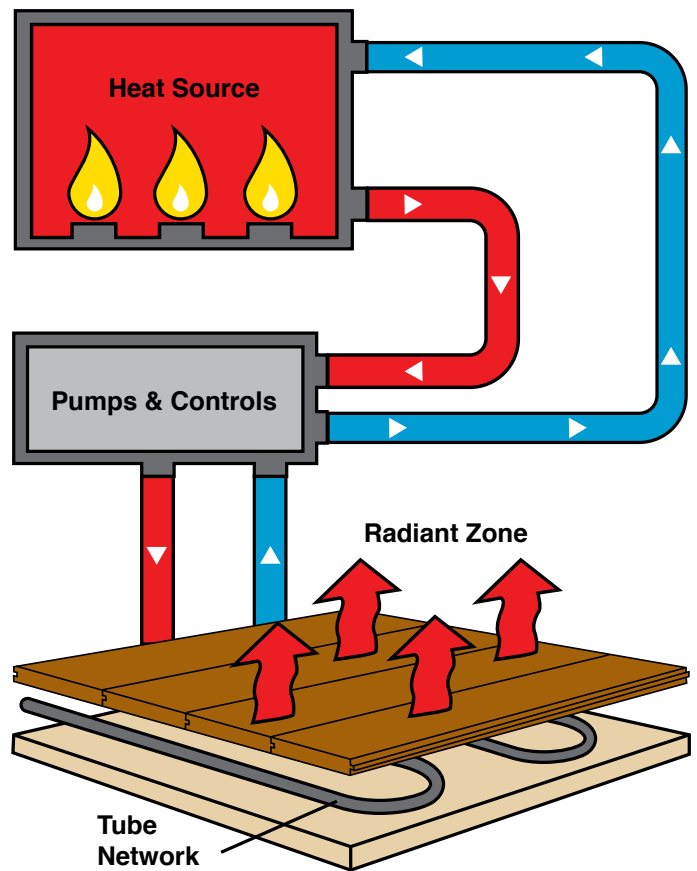

NOTE: Diagram is to explain general principles of radiant heat. See Hallmark Healthy Home for full explanation of approved systems and applications.

Below Grade Installation

A concrete slab is considered below grade when any part of the slab is below ground level. For example, a basement with a walk out is considered below grade. A house cut into a hill is also considered to be below grade if it isn't properly graded to create a drainage swale on the lot. Below grade slabs must be carefully tested. Diligently follow all adhesive manufacturer's instructions for below grade installation.

Getting Started

1. Select Installation Type

ABOVE GRADE WOOD SUB FLOOR: Glue (Sheet with Baltic Birch plywood underlayment).

WOOD SUB FLOOR WITH CRAWL SPACE/ BASEMENT: Glue (Sheet with Baltic Birch plywood underlayment).

ON/ABOVE-GRADE CONCRETE: Glue (vapor abatement recommended for on grade installation).

BASEMENT: Glue with vapor abatement system.

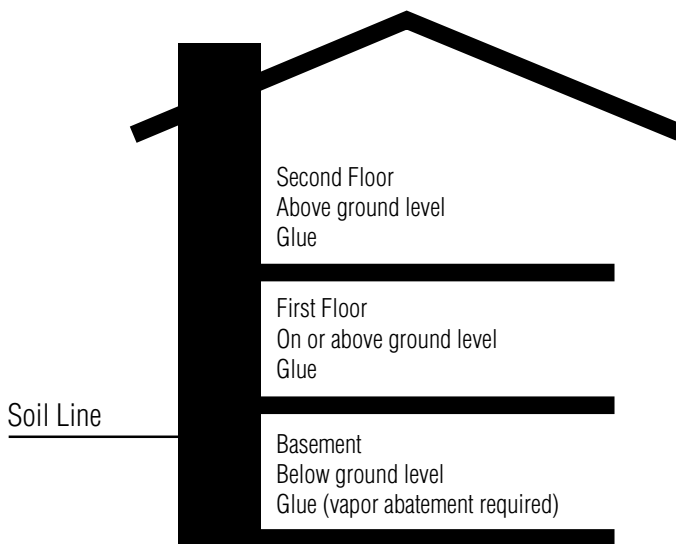

2. Cabinets & Appliances

Cabinets and built in appliances (sub-zero refrigerators & dishwashers) should be installed prior to the installation of the luxury vinyl floor. Cabinets and built in appliances should not be installed on top of the floor. Installation of cabinets on top of glue down installation does not invalidate warranty. However, since this is not best practice, should the floor require repair under warranty, Hallmark Floors will not be liable for costs to remove and replace cabinets and or counter tops to effect repair.

Luxury vinyl flooring should be installed at the same time as carpet and after the following: finishing walls, cabinet installation, appliance installation, tile & counter top installation.

Standard refrigerators and kitchen oven/range are acceptable for placement on top of the luxury vinyl floor. Use caution when moving appliances by using a proper furniture dolly, air sled, 1/8" Masonite with glossy side down, or plastic glides designed for movement of heavy appliances. Failure to follow these precautions will damage the floor.

3. Undercut All Door Jambs/Moldings

Remove all shoe and base molding to ensure adequate expansion space. Use scrap piece of flooring to establish height of cut. Make allowances for adhesive or underlayment thickness when establishing height of cut.

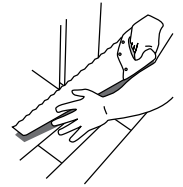

4. Visual Inspection of Planks/Tiles

Visually inspect planks/tiles for any defects prior to installation. Verify that homeowner has seen product and approves proceeding with installation of the floor.

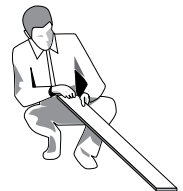

5. Open Multiple Boxes

Always work from multiple boxes simultaneously and blend the planks/tiles throughout the installation. This is especially important with mixed production dates. Hallmark has very good color consistency, and mixed production dates are acceptable for installation. Working from multiple boxes/production dates helps achieve a good blend of color.

6. Blend Boards to Moldings

Before you get started, open multiple boxes and check how the planks/tiles blend with the moldings. At beginning of installation, set aside those planks/tiles that best blend to the transition moldings on job.

7. Select a Starter Wall

When installing luxury vinyl, it is recommended to base the layout of the installation off of an exterior wall. Check to make sure the wall is straight and square to the room.

8. Starting Line

For starting row, cut blocks to use against side and end walls to maintain ¼" minimum expansion space. Use spacers at both side the end of the rows. Use of adjustable spacers may be needed to help maintain a straight line.

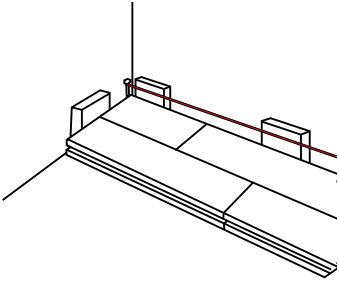

9. Irregular & Out-of-Square Walls

Scribe cut the first row to match variations in the wall. A scribe can be created by drilling a hole in a scrap piece of wood and inserting a pencil. The starting row can then be cut to compensate for an irregular wall or to help minimize the appearance of an out of square room by splitting the difference between the two walls.

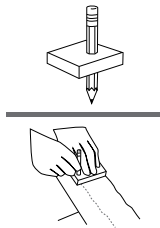

Glue Down Installation - Plank

2MM: Town & Country, Castle & Cottage

3MM: El Dorado, Sierra Madre, Times Square

Before installing any material, plan the layout of the plank end joints to avoid lining up on top of the sub floor/underlayment joints. Do not install plank end joints over expansion joints.

Installation Tools GLUE DOWN PLANK

Tape measure, pencil, chalk line, table saw, cut-off saw, vinyl guillotine, jamb saw, spacers, hammer, safety glasses, hearing protection, utility knife, specified notched trowel, wall spacers, straight edge, broom, speedy square, luxury vinyl floor cleaner, and shop vacuum.

NOTE: Hallmark Floors recommends pattern scribing, with utility knife or cutting with a power miter saw or vinyl guillotine cutter for cutting luxury vinyl plank.

10 GDP. Measure the Room

Accurately measure the room to determine the center line, and total width of the floor. The width can be divided by the width of the plank. This helps establish how many rows are required. The starting row and ending row can then be trimmed so the width of the starting plank and ending plank can be the same. Once this is known the starting row can be ripped to a narrower width if necessary, to give the floor balance.

11 GDP. Establish End Joint Pattern

Plank ends should be staggered, randomly to avoid a cluster or stair stepping of end joints. Varying the length of the starter plank will give the appropriate stagger for that row.

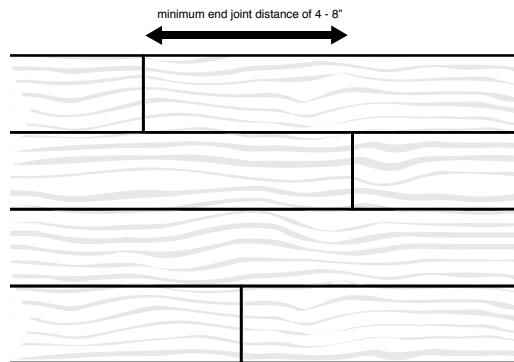

12 GDP. Starter Rows

Measure the equivalent of four to five rows, mark sub floor at both ends of run and snap a chalk line. Spread adhesive to chalk line. Repeat this process on all subsequent rows of material throughout the balance of installation.

If starting from a center line, begin laying Hallmark Floors luxury vinyl flooring along the starting line and work back to the starting wall.

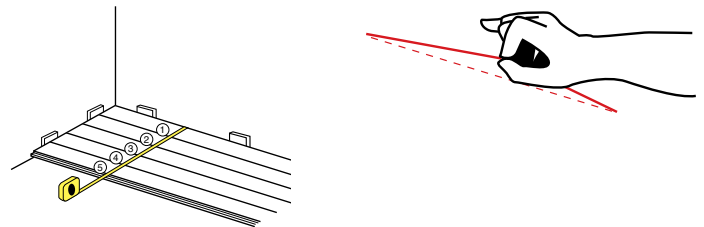

13 GDP. Set Planks

Spread adhesive and set plank into the adhesive while avoiding any movement of the plank. Clean up all adhesive residue from surface of floor as you proceed. Do not allow adhesive to dry on the surface of the planks.

14 GDP. Directional Installation

Ensure the planks are installed with the arrows imprinted on the back of the planks are laying in the same direction. If there are no arrows, the material is non-directional, and can be installed in either direction.

15 GDP. Roll Floor

After completion of the installation, the floor must be rolled with a minimum 100 lb. 3-section floor roller in both directions. Cover steel rollers with fresh duct tape before every use to prevent steel rollers damaging the surface of the floor.

16 GDP. Install Trim/Moldings

Cover all exposed areas. Use appropriate trim pieces along all walls, cabinets, etc. Use appropriate transition pieces in doorways or where Hallmark Floors luxury vinyl meets other flooring.

17 GDP. Clean Up

Remove all glue residue from the floor and vacuum up remaining debris.

Other than glue residue removal and vacuuming, do not clean the floor for 48 hours after installation. After 48 hours, use a damp mop with well-wrung-out sponge mop to remove residue and clean with Hallmark Trueclean.

ATTENTION!: Exposure to direct sunlight and other heat sources may affect the performance of the floor. Temporary paper shades/sheets over windows/glass doors can protect the floor surface from excessive heat and light. This will provide a measure of protection until permanent window coverings can be installed.

Glue Down Installation Hermosa Stone Tile

3MM: Hermosa Stone 18" x 18" tile

Before installing any material, plan the layout of the tile end joints to avoid lining up on top of the sub floor/underlayment joints. Do not install tile joints over expansion joints.

Installation Tools GLUE DOWN HERMOSA STONE TILE

Tape measure, pencil, chalk line, table saw, vinyl guillotine, jamb saw, spacers, hammer, safety glasses, hearing protection, utility knife, specified notched trowel, wall spacers, straight edge, broom, speedy square, luxury vinyl floor cleaner, and shop vacuum.

NOTE: Hallmark Floors recommends pattern scribing with a utility knife or cutting with a power miter saw or vinyl guillotine cutter for cutting luxury vinyl tile.

10 GDHS. Center Point & Chalk Lines

Square tile cannot be installed using the same layout techniques as plank. Tile must begin from the center of the room. This will allow plenty of space to work outward to the walls to ensure a symmetrical pattern.

Establish the center point in the room by marking the center point of all four walls. Snap chalk lines between the center points of opposite walls. Make sure they're perfectly square and adjust as necessary.

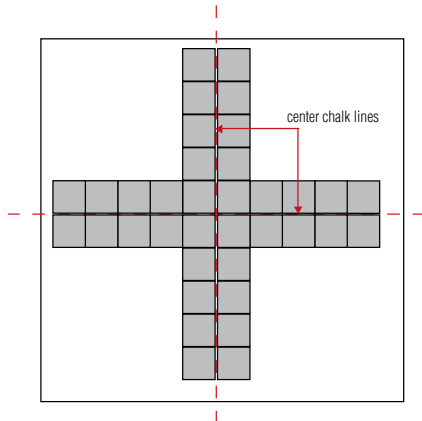

11 GDHS. Pattern Layout

Loose lay a row of tile along the center lines in both directions. If you have an unbalanced edge from one side to the other adjust your center line to maintain balance. Avoid having one edge with very thin tile and the other very wide. If using Bostik TruColor Polyurethane Grout, make sure you include spacers when planning the layout.

L-shaped Room

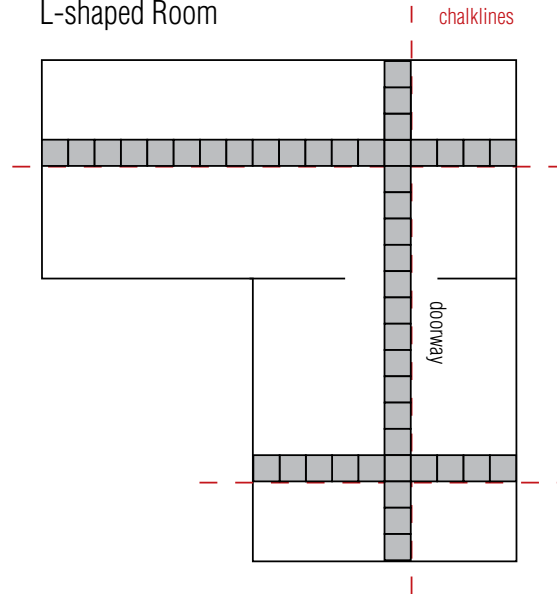

12 GDHS. Diagonal Pattern Layout

If installing Hermosa Stone on a 45° angle (diamond pattern), establish grid lines that allow the floor to be laid out in a balanced pattern.

NOTE: See Basic Pattern Section for more pattern options.

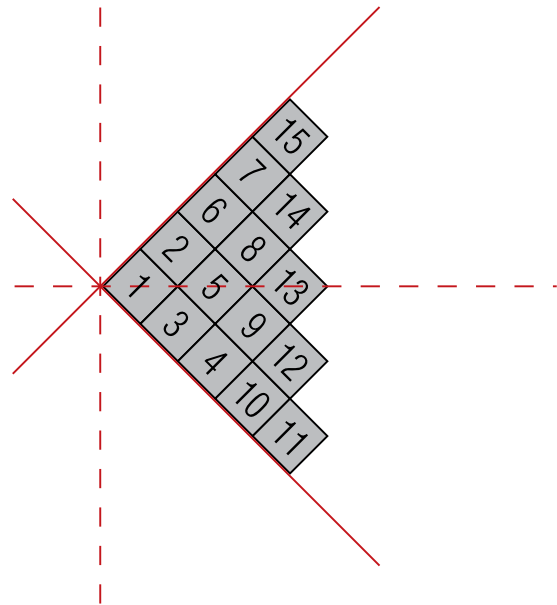

12 GDHS. Cutting Tiles

Tiles can be cut by pattern scribing with utility knife and snapping the tile, or by cutting with a vinyl guillotine cutter or table saw with a sharp, high tooth-count blade. (Tile is too wide to cut with chop saw).

13 GDHS. Set Tiles

Spread adhesive and set tile into the adhesive while avoiding any movement of the tile.

After installation has begun, begin laying Hallmark Floor luxury vinyl tiles along the starting lines and work out towards the surrounding walls.

Clean up all adhesive residue from surface of floor as you proceed. Do not allow adhesive to dry on the surface of the tiles.

14 GDHS. Roll Floor

After completion of the installation, the floor must be rolled with a minimum 100 lb. 3-section floor roller in both directions. Cover steel rollers with fresh duct tape before every use to prevent steel rollers damaging the surface of the floor.

15 GDHS. Install Trim/Moldings

Cover all exposed areas. Use appropriate trim pieces along all walls, cabinets, etc. Use appropriate transition pieces in doorways or where Hallmark Floors luxury vinyl meets other flooring.

16 GDHS. Grouting (optional)

When grouting, Hallmark Floors recommends Bostik TruColor. Bostik TruColor is known to be compatible with Hallmark Floors Surface Guardian Refresher, and Hallmark Floors ABC Recoat System. When using Bostik TruColor, only spread 8 to 10 sq. ft. at a time and clean up with sponge per Bostik instructions. Do not use any maintenance products on the floor for 48 hours.

NOTE: Other grout manufacturers have premixed grouts, mostly acrylic, that can be used to grout luxury vinyl tile. However, it is not known if Hallmark Floors Surface Guardian Refresher or ABC recoat systems will stick to them.

17 GDHS. Clean Up

Remove all glue residue from the floor and vacuum up remaining debris.

Other than glue residue removal and vacuuming, do not clean the floor for 48 hours after installation. After 48 hours, use a damp mop with well-wrung-out sponge mop to remove residue and clean with Hallmark Trueclean.

ATTENTION!: Exposure to direct sunlight and other heat sources may affect the performance of the floor. Temporary paper shades/sheets over windows/glass doors can protect the floor surface from excessive heat and light. This will provide a measure of protection until permanent window coverings can be installed.

18" x 18" Basic Patterns

Hermosa Stone

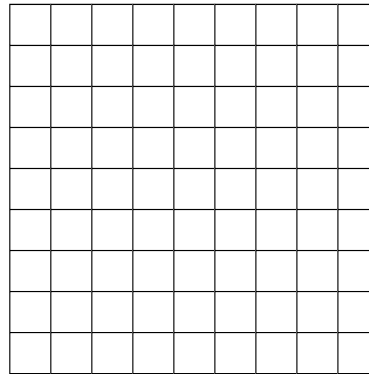

Checker Board

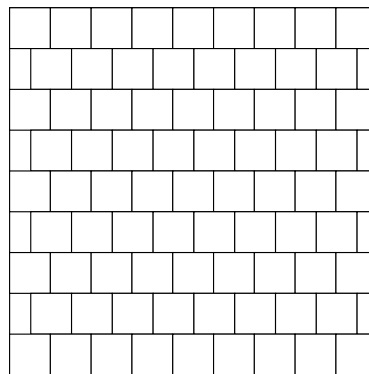

Brick

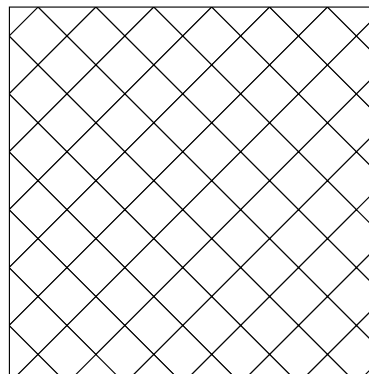

Checker Board 45°

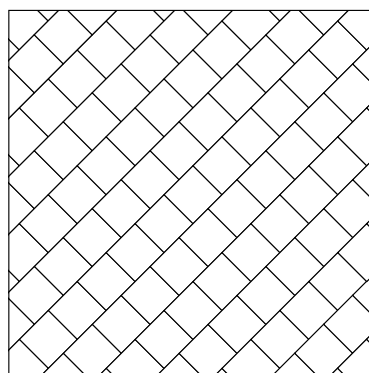

Brick 45°

Glue Down Installation

Times Square Tile

3MM: Times Square 18"x36" tile

Note: Times Square is a large format rectangular tile. Proper layout is critical to the performance and appearance of the product.

Before installing any material, plan the layout of the tile end joints to avoid lining up on top of the sub floor/underlayment joints. Do not install tile joints over expansion joints.

Installation Tools GLUE DOWN TIMES SQUARE TILE

Tape measure, pencil, chalk line, table saw, vinyl guillotine, jamb saw, spacers, hammer, safety glasses, hearing protection, utility knife, specified notched trowel, wall spacers, straight edge, broom, speedy square, luxury vinyl floor cleaner, and shop vacuum.

NOTE: Hallmark Floors recommends pattern scribing, with utility knife or cutting with a power miter saw or vinyl guillotine cutter for cutting luxury vinyl tile.

10 GDTS. Center Point & Chalk Lines

Rectangular tile cannot be installed using the same layout techniques as plank. Tile must begin from the center of the room. This will allow plenty of space to work outward to the walls to ensure a symmetrical pattern.

Establish the center point in the room by marking the center point of all four walls. Snap chalk lines between the center points of opposite walls. Make sure they're perfectly square and adjust as necessary.

11 GDTS. Pattern Layout

Loose lay a row of tile along the center lines in both directions. If you have an unbalanced edge from one side to the other adjust your center line to maintain balance. Avoid having one edge with very thin tile and the other very wide. If using Bostik TruColor Polyurethane Grout, make sure you include spacers when planning the layout.

Times Square rectangular tile has many options for installation layout. Ensure you are familiar/experienced with these types of installation as chalk layout lines will have to be used to ensure the pattern does not drift. 18" x 36" tiles are large format, and some patterns may not be suitable for smaller rooms. Dry lay a small portion of the pattern or graph out room size on paper.

The starting point in a modular installation must be as close to the center of the room as possible and must be positioned to center the pattern in the room. Snap a chalk line parallel to one major wall bisecting the starting point. It may be necessary to offset the center chalk line to assure perimeter modules will be at least half size.

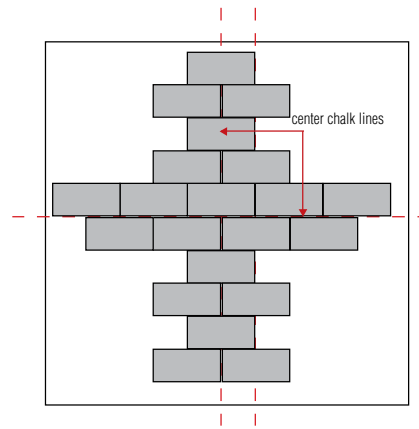

L-shaped Room

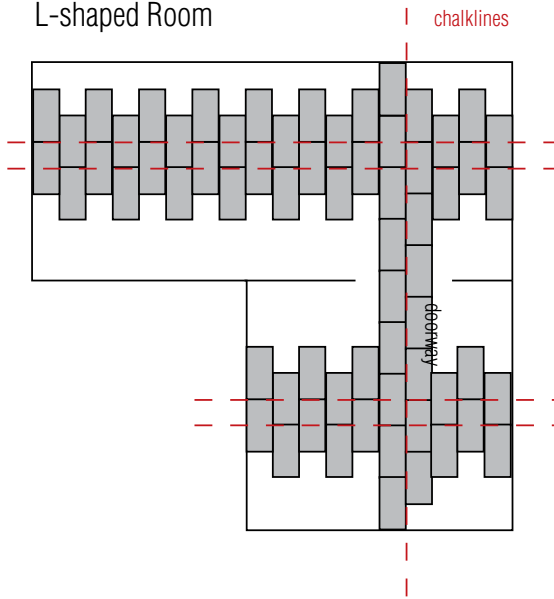

12 GDTS. Diagonal Patterns

If installing Times Square tile on a 45° angle, establish grid lines that allow the floor to be laid out in a balanced pattern.

NOTE: See Basic Pattern Section for more pattern options.

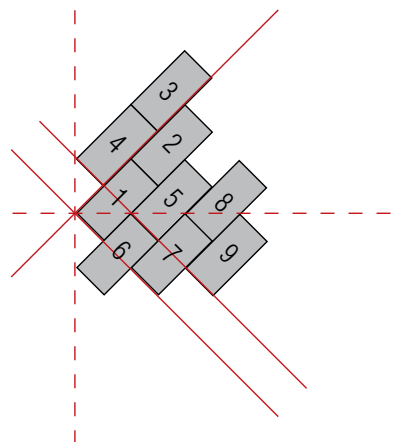

12 GDHS. Cutting Tiles

Tiles can be cut by pattern scribing with utility knife and snapping the tile, or by cutting with a vinyl guillotine cutter or table saw with a sharp, high tooth-count blade. (Tile is too wide to cut with chop saw).

13 GDHS. Set Tiles

Spread adhesive and set tile into the adhesive while avoiding any movement of the tile.

After installation has begun, begin laying Hallmark Floor luxury vinyl tiles along the starting lines and work out towards the surrounding walls.

Clean up all adhesive residue from surface of floor as you proceed. Do not allow adhesive to dry on the surface of the tiles.

14 GDHS. Roll Floor

After completion of the installation, the floor must be rolled with a minimum 100 lb. 3-section floor roller in both directions. Cover steel rollers with fresh duct tape before every use to prevent steel rollers damaging the surface of the floor.

15 GDHS. Install Trim/Moldings

Cover all exposed areas. Use appropriate trim pieces along all walls, cabinets, etc. Use appropriate transition pieces in doorways or where Hallmark Floors luxury vinyl meets other flooring.

16 GDHS. Grouting (optional)

When grouting, Hallmark Floors recommends Bostik TruColor. Bostik TruColor is known to be compatible with Hallmark Floors Surface Guardian Refresher, and Hallmark Floors ABC Recoat System. When using Bostik TruColor, only spread 8 to 10 sq. ft. at a time and clean up with sponge per Bostik instructions. Do not use any maintenance products on the floor for 48 hours.

NOTE: Other grout manufacturers have premixed grouts, mostly acrylic, that can be used to grout luxury vinyl tile. However, it is not known if Hallmark Floors Surface Guardian Refresher or ABC recoat systems will stick to them.

17 GDHS. Clean Up

Do not clean the floor for 48 hours after installation.

After 48 hours, use a damp mop with well-wrung-out sponge mop to remove residue and clean with Hallmark Trueclean.

ATTENTION!: Exposure to direct sunlight and other heat sources may affect the performance of the floor. Temporary paper shades/sheets over windows/glass doors can protect the floor surface from excessive heat and light. This will provide a measure of protection until permanent window coverings can be installed.

18" x 36" Basic Patterns

Times Square Rectangular Tile

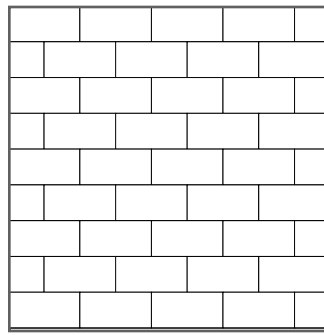

Brick

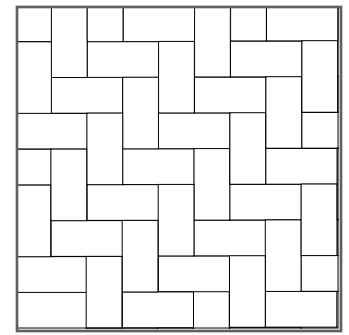

Herringbone 90°

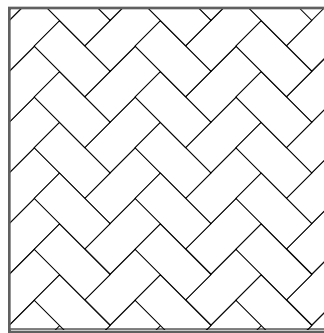

Herringbone 45°

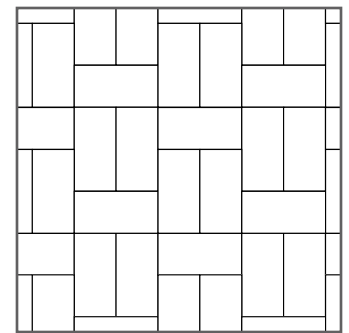

Single Basket Weave

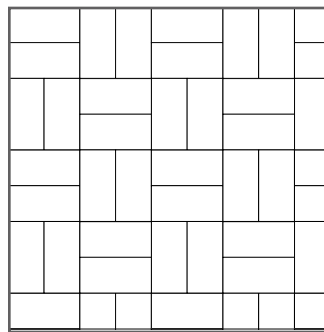

Double Basket Weave

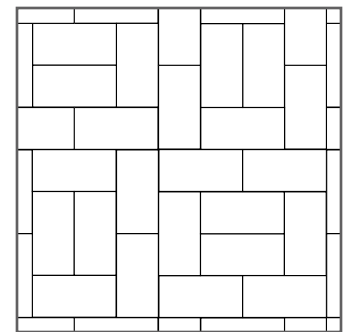

Wrapped Basket Weave

18" x 36" Pattern Setup

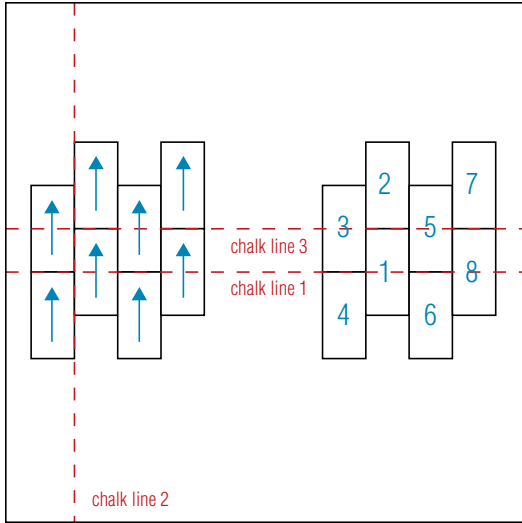

Brick

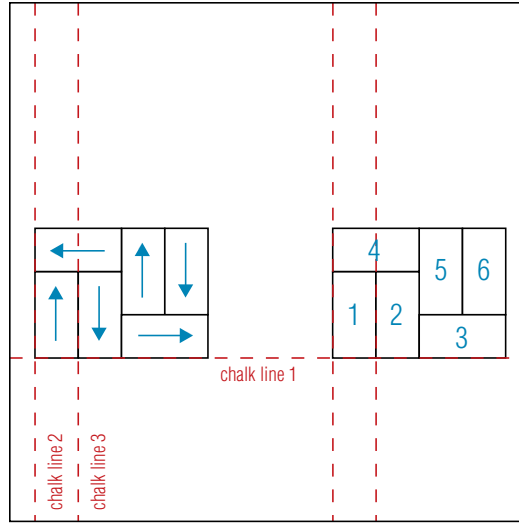

Single Basket Weave

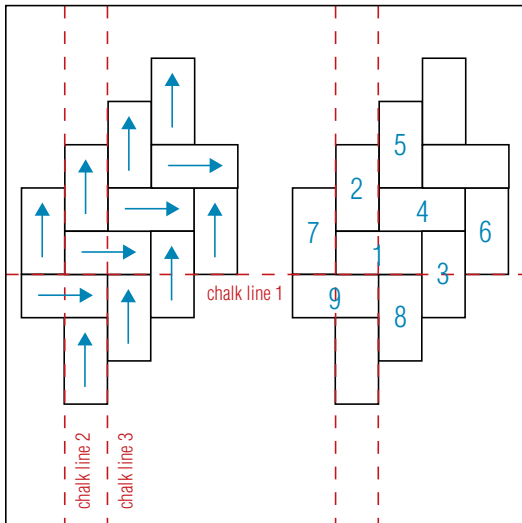

Herringbone 90°

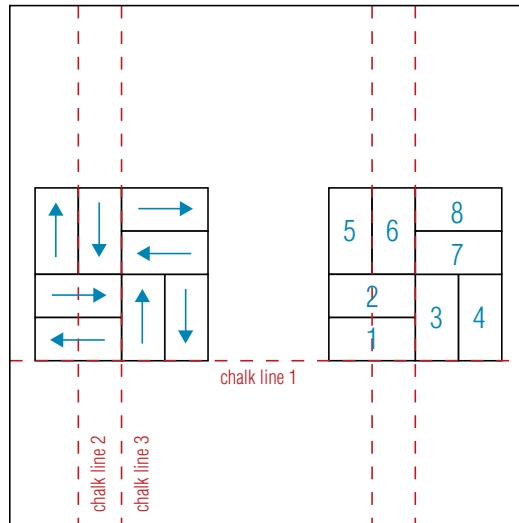

Double Basket Weave

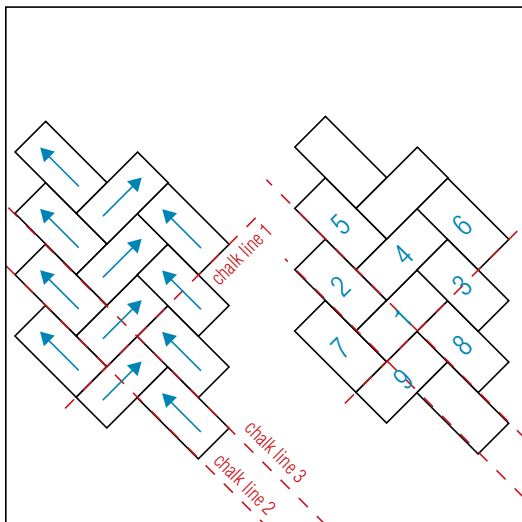

Herringbone 45°

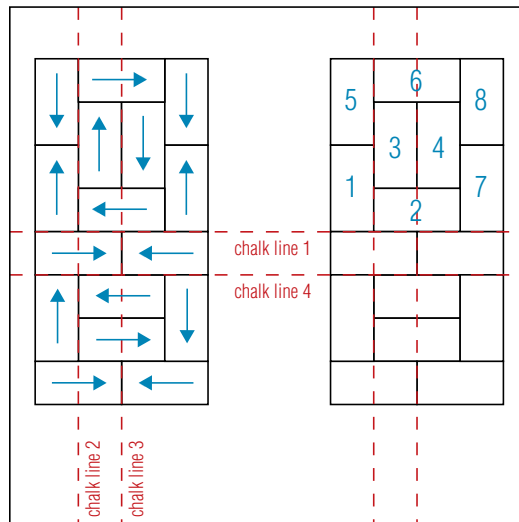

Wrapped Basket Weave

Hallmark Luxury Vinyl Primer, Sealer, & Adhesive Systems

HALLMARK 1 LUXURY VINYL PRIMER

HALLMARK 2 LUXURY VINYL SEALER

HALLMARK 3 LUXURY VINYL ADHESIVE

HALLMARK STANDARD 4 LUXURY VINYL ADHESIVE

Hallmark 1 Luxury Vinyl Concrete Primer

Primer for Lightweight Concrete / Gypcrete with 2500psi rating (using a foam roller).

Use as a primer over epoxy sealers

Use as a primer over radiant heat, lightweight concrete, Gypcrete

Used prior to any approved leveling compound (Use filler compatible with sub floor construction type)

FOR USE WITH:

Hallmark 3 Adhesive

Hallmark Standard 4 Adhesive

DESCRIPTION: Hallmark 1 Primer is a pure acrylic-based sealer for flooring installation. It does not contain any solvents, isocyanates, or other harmful materials. It is, therefore, ozone and environmentally safe, is certified as "very low emissions", and certified "green". Hallmark 1 Primer lowers the moisture levels from a humid sub floor to an acceptable level for flooring installation and bridges minor cracks in the sub floor. Hallmark 1 Primer spreads easily, creates a dust free surface, has superior coverage, and dries very quickly.



PRE-INSTALLATION: A successful installation requires proper preparation of the sub floor. Read and understand all applicable guidelines for sub floor moisture, and layout of flooring. All flooring to be installed must meet the flooring requirements before the floor is installed.

SUB FLOOR: Prior to installation, the sub floor must be sound, dry, clean, free of any adhesives, resistant to pressure, and its tension checked according to applicable installation guidelines. It must be solid, sound, flat, permanently dry, clean, free of chips, indentations and anti-adherents, as well as resistant to pressure and tension. See sub floor preparation section at front of book.

SUB FLOOR PREPARATION: The condition of the sub floor will determine which type of mechanical treatment is required (e.g. wire brushing, sanding, grinding or shot blasting). Dust, paint, curing compounds, sealers, residual adhesives, or other surface pollutants MUST be removed. Clean the surface with an industrial vacuum cleaner, tack or damp mop floor before application. Cracks and gaps must be treated prior to application of primers, sealers, leveling compounds, and/or adhesives.

PROCEDURE: Shake before use and apply sealer undiluted with appropriate applicator. Make sure sealer is spread evenly. Do not exceed the maximum coverage. Higher temperatures will speed up the drying time.

LIMITATIONS: When using non-Hallmark Floors products in conjunction with Hallmark Floors primers, sealers, or adhesives, Hallmark Floors denies any and all responsibility for any problems and/or damages without prior written approval from Hallmark Floors. In case of accident, injury, spill, or exposure, see SDS sheet for more information. Do not dilute primer/sealer or mix with other products.

FEATURES: Dries in less than 2 hours, contains no solvents, contains no VOC nonflammable, ozone friendly, cleans with water, bridges cracks. *Warning: not freeze/thaw stable.*

BENEFITS: Cleans with warm water and soap, Easily applied (trowel or roller method) good penetration of sub floor, dries quickly (higher temp will shorten drying time), suppresses minor cracks in concrete slabs, no risk of sensitization.

LONG TERM FEATURES: Improves bonding of Hallmark 3 and Hallmark Standard 4 adhesives, moisture barrier up to 8lbs or 85% RH (when applied with #22 trowel suitable for radiant heat systems, no health hazards.

APPROVED SUB FLOORS: Concrete slabs, lightweight concrete, gypcrete.

APPROVED APPLICATORS: Foam or Short Nap Roller (up to 500 sf/gal)

COLOR: Cream

PH VALUE OF CONCRETE: Below 12.4

WATER VAPOR TRANSMISSION (ASTM E-96):

0.118 grams/hour *m²

0.58 lbs./24 hr. ft² inHg

PERMEANCE (ASTM E-96):

0.27 grams/24h *

0.41 grams/h *ft² in Hg

STORAGE: Above 32°F, not freeze/thaw stable

SHELF LIFE: 12 months in original, unopened jug.

Hallmark 2 Luxury Vinyl Concrete Sealer

Moisture barrier up to 18 lbs. on Calcium Chloride or 97% RH In-Situ Probe Test (using foam roller with max coverage of 140 sf per gallon.

OR

Moisture barrier up to 25 lbs. on Calcium Chloride or 100% RH In-Situ Probe Test (using #22 trowel with max coverage of 70 sf per gallon.

Contains no water, solvents or VOC's.

FOR USE WITH:

Hallmark 3 Adhesive. *Not compatible with Hallmark Standard 4.*

Not for use on radiant heat, lightweight concrete spale, or gypcrete.

DESCRIPTION: Hallmark 2 Sealer is a two component, epoxy reaction, resin-based sealer for flooring installation over high moisture sub floors. Hallmark 2 Sealer will lower moisture levels from a high moisture sub floor to an acceptable level, and will bridge minor cracks in the sub floor. Hallmark 2 Sealer spreads easily, and creates a dust free surface for your flooring installation. Hallmark 2 Sealer increases the bonding of applied primers, leveling compounds and/or adhesives



PRE-INSTALLATION: A successful installation requires proper preparation of the sub floor. Read and understand all applicable guidelines for sub floor moisture, and layout of flooring. All flooring to be installed must meet the flooring requirements before the floor is installed.

SUB FLOOR: Do not apply Hallmark 2 Sealer onto a visibly damp or wet surface. Examine concrete sub floor for color, cleanliness, porosity and pre-existing residues PRIOR TO installation. Check the concrete sub floor for any contaminants and follow installation guidelines for proper sub floor preparation. It must be sound, permanently dry, clean, free of old adhesive or adhesive residue, as well as resistant to pressure and tension. Moisture content of all floors must be measured before installation.

SUB FLOOR PREPARATION: The condition of the sub floor will determine which type of mechanical treatment is required (e.g. wire brushing, sanding, grinding or shot blasting). Dust, paint, curing compounds, sealers, residual adhesives or other surface pollutants MUST be removed. Clean the surface with an industrial vacuum cleaner, tack or damp mop floor before application. Cracks and gaps must be treated prior to application.

MIXING OF COMPONENTS: Lid contains the hardener. Pierce all the way through the plastic disc in center of lid and the bottom of the lid using a long screwdriver or similar tool. Let the hardener flow into the lower part of the bucket. Remove the lid, and using a mixing paddle, mix both for at least 3 minutes using an electric drill with less than 300 rpm until an even color is reached. Mix slowly using the correct mixing paddle to avoid trapping air. Make sure to mix along wall and bottom of the container as well. Temperature of both components should be at least 50°F before mixing. Empty the entire contents of the pail onto floor immediately after mixing to prevent sealer from heating up and drying in the pail.

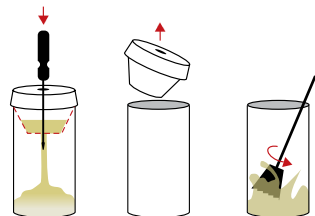

INSTALLATION PROCEDURE: After mixing, apply, undiluted, to the sub floor using the approved applicator. Make sure sealer is spread evenly and up to the perimeters for a successful installation. Do not exceed the maximum coverage.

Foam Roller Application for sub floor moisture up to 18lbs/24hrs/1,000SF (calcium chlorite test) or 97% RH (in-situ probe), spread Hallmark 2 Sealer over no more than 140 SF/gal.

#22 Trowel Application for sub floors with a moisture content up to 25lbs/24hrs/1,000SF (calcium chlorite test) or 100% RH (in-situ probe test).

LIMITATIONS: When using non-Hallmark products in conjunction with Hallmark primers, sealers, or adhesives, Hallmark denies any and all responsibility for any problems and/or damages without prior written approval from Hallmark. Sealer will not prevent moisture damages from hydrostatic pressure, underground springs, compromised vapor barriers underneath the slab, damaged water pipes, sinks, icemakers, faulty plumbing, flooding, etc.

FEATURES: Seals slabs with any moisture content, contains no solvents, contains no VOC, contains no water, high solids content, ozone friendly, freeze/thaw stable, contains no isocyanates.

BENEFITS: Low odor, high spread rate, spreads easily, excellent penetration of sub floor (higher temp and will shorten drying time).

CAUTION: *Watch pot life during installation.*

LONG TERM FEATURES: Resistant against aging, improves bonding of urethane-based adhesives, improves bonding of polymer adhesives, moisture barrier up to 18lbs. or 97% RH w/roller, moisture barrier up to 25 lbs. or 100% RH w/trowel, suitable for radiant heat systems.

APPROVED SUB FLOORS: Concrete slabs, wet concrete slab up to 25lbs/24hrs/1,000SF and 100% RH Stone, Terrazzo

APPROVED APPLICATORS:

Foam Roller: up to 140 sf/gal #22

Trowel: 7/64" x 5/64" (up to 70 sf/gal)

DRYING TIME: 12-18 hours, completely cured after 7days

TEMPERATURE DURING INSTALLATION: 50°to 90°F

RELATIVE HUMIDITY DURING INSTALLATION: 30% to 80%

COLOR (HARDENER): Yellow

POT LIFE: Approx. 25 min at 70°F (21°C)

PH VALUE OF CONCRETE: Up to 14

WATER VAPOR TRANSMISSION (ASTM E-96):

0.012 grams/hour * m2

0.06 lbs/24 h * ft2 inHg

PERMEANCE(ASTM E-96):

0.026 grams/24h * m2 mmHg

0.04 grams/h * ft2 inHg

STORAGE: Above 14°F

Hallmark 3 Luxury Vinyl Adhesive

For wet lay installation (wet set) use XTR1 1/16" x 1/16" x 1/16" trowel.

OR

For dry installation (pressure sensitive / releasable / dry set) use #9 -1/32" x 1/16" x 1/32" trowel.

Long open time (wet set = 1hr., dry set = 2hrs.).

FOR USE WITH:

Hallmark 1 Primer

Hallmark 2 Sealer

Can be used over cutback mastic stained concrete when used in conjunction with Hallmark 2 Sealer.

DESCRIPTION: Hallmark 3 Adhesive can be used with all Hallmark Floors luxury vinyl. It has a great green strength, high tensile strength, and a very long open time. Hallmark 3 Adhesive installation methods can be installed using the wet lay method, or even the traditional drier pressure-sensitive type of installation. It can also be used in a wet lay installation on a concrete slab, when installing over existing non-absorbent flooring. Hallmark 3 Adhesive can be applied directly over Hallmark 1 Primer or Hallmark 2 Sealer. Hallmark 3 is non-hazardous, contains no VOC, is certified as "very low emission" by an independent third party laboratory, and is eligible for LEED points.



SUB FLOOR PREPARATION: Concrete Sub floors -The condition of the sub floor will determine which type of mechanical treatment is required (e.g. wire brushing, sanding, grinding or shot blasting). Dust, paint, curing compounds, sealers, residual adhesives or other surface pollutants MUST be removed. Clean the surface with an industrial vacuum cleaner, tack or damp mop floor before application. Cracks and gaps must be treated prior to application of primers, sealers, leveling compounds, and/or adhesives with a concrete filler unless they are expansion joints. Substrate must be level to 3/16 inches within 10 feet. Heated sub floors (radiant heat) must be primed.

Wood sub floors must be covered with kiln-dried Baltic birch underlayment plywood such as HalexBaltic Birch, IntegrawoodIntegraPly, Mooreland UltraplyXL underlayment panels, or equivalent. 5/8" sub floors should be covered with 9mm/ 7 ply and 3/4" sub floors covered with 6mm/5 ply Baltic Birch plywood. Hallmark Floors does not warrant our products directly installed to the above sub floors, nor do we accept the use of particle board, O.S.B, Luan, or Maranti types of underlayment.

INSTALLATION PROCEDURE: Spread the adhesive with the appropriate notched trowel at a 45° angle in order to avoid excessive adhesive thickness. Observe the appropriate flash time (if applicable). Lay the flooring into the adhesive, correctly position it, and press down firmly. Ensure good adhesive transfer by checking the back of the flooring. Roll flooring approx. 15-30 min after installation with a 100 lb. roller. Push down raised edges approx. 30-60 min after installation.

A. Wet Lay (wet set): Use a XRT1 -1/16"x1/16"x1/16" trowel for all general installations.

B. Dry Lay (dry set -pressure sensitive/releasable): Use a #9 -1/32" x 1/16"x 1/32" trowel for dry-lay / pressure sensitive installation.

LIMITATIONS: When using non-Hallmark products in conjunction with Hallmark primers, sealers, or adhesives, Hallmark denies any and all responsibility for any problems and/or damages without prior written approval from Hallmark. In case of accident, injury, spill or exposure, see SDS sheet for information.

Hallmark 3 adhesive will maintain its integrity and performance even when higher levels of moisture are present. While adhesive can withstand up to 8#/24 hrs./1,000 SF (Calcium Chloride Test) and 85% RH (in-situ probe) of moisture, it does not qualify as a moisture inhibitor. Hallmark 2 must be used Please see below for recommended sealers if a moisture barrier is required.

FEATURES: LEED qualified, contains no chlorinated solvents, contains no solvents, contains no VOC, nonflammable, ozone friendly, certified green certified very low emission, *CAUTION: not freeze/thaw stable.*

BENEFITS: Long open time, spreads easily (higher temp will shorten drying time), No risk of sensitization.

LONG TERM FEATURES: resistant against aging, suitable for radiant heat systems (when Hallmark 1 is used to prime concrete / lightweight concrete / gypcrete thermal mass), no health hazards.

APPROVED FLOORING: Hallmark Floors luxury vinyl collections: Town & Country, Castle & Cottage, El Dorado, Sierra Madre Hermosa Stone, and Times Square.

NOTE ON HALLMARK FLOORS PRODUCTS WITH EZ LOC (LOCKING SYSTEM):

San Simeon Luxury Vinyl Plank

Polaris Premium Vinyl Plank

Courtier Premium Vinyl Plank

These products will stick to Hallmark 3 and 4. Glue down of these Hallmark Floors collections is possible. However, installation is very challenging and time consuming. Proceed at your own discretion. No claims will be honored for additional time required to glue down EZ Loc Collections.

For glue down applications of EZ Loc, follow all directions in EZ Loc installation instructions (separate instruction booklet). Disposable vinyl gloves are very helpful in keeping adhesive off of hands and plank surfaces. Clean up all glue residue from surface of plank as job proceeds.

APPROVED SUB FLOORS:

Concrete (must be clean, dry, flat).

Concrete - cutback mastic stain (well bonded, negative for asbestos).

OSB (underlayment grade) see Hallmark Floors installation Instructions. (requires Baltic Birch on top, filled and sanded).

Plywood (underlayment grade) see Hallmark Floors installation instructions (requires Baltic Birch on top, filled and sanded).

Dried leveling compounds, structurally sound and suitable for use as glue down surface.

Radiant heat, above sections apply, see radiant heat section of these instructions.

NOTE: Hallmark 3 Adhesive will stick to both osb and plywood. However, both sub floors will move and the texture of their surfaces will telegraph through the floor. This is not considered a manufacturing defect, and is not covered under Hallmark Floors warranty.

FLASH TIME:

Wet Lay: 5-25 min at 70°F (21°C)

Dry Lay: up to 60 min at 70°F (21°C)

RELATIVE HUMIDITY DURING INSTALLATION: 30% to 80%

COLOR: Cream

Hallmark 3 Luxury Vinyl Adhesive (continued)

POT LIFE: 12 months in original, unopened pail.

PH VALUE: Below 12.4

STORAGE: Above 32°F, Caution not freeze/thaw stable

SHELF LIFE: 24 months in original, unopened container

OPEN TIME:

Wet Lay: up to 60 min at 70°F (21°C)

Dry Lay: up to 2 hours at 70°F (21°C)

APPROVED PRIMERS: Hallmark 1 Primer

APPROVED SEALERS: Hallmark 2 Sealer

APPROVED TROWELS:

Wet Lay / Wet Set: 1/16" x 1/16" x 1/16" (up to 170 sf/gal)

Dry Lay / Pressure Sensitive –Releasable : 1/32" x 1/16" x 1/32" (up to 250 sf/gal)

DRYING TIME: Approx. 24 hours

CLEAN UP: Soap and water

TEMPERATURE DURING INSTALLATION: 50°to 90°F

Hallmark Standard 4 Luxury Vinyl Adhesive

FOR USE OVER:

Hallmark 1 Primer treated concrete, light weight concrete, gypcrete, Baltic Birch or equivalent wood substrate.

Not for use over radiant heat.

DESCRIPTION: Hallmark Standard 4

Adhesive is a highly specialized flooring adhesive specifically designed for luxury vinyl flooring. It has very high shear strength and is very installer-friendly due to its long open time. Hallmark Standard 4 Adhesive contains no VOC's and due to its green properties, is eligible for LEED.



PRE-INSTALLATION: Proper preparation of the sub floor is required for a successful installation. Please read all the guidelines instructions for the adhesive before proceeding with the installation. Follow Hallmark Floors' glue down installation instructions for proper sub floor moisture readings, layout, and application of flooring materials.

SUB FLOOR: Prior to installation, it's imperative that the sub floor is checked according to industry guidelines. It must be solid, sound, flat, dry, clean, free of indentations, voids, anti-adherents, as well as resistant to tension and pressure. Moisture content must be measured before proceeding with the installation.

SUB FLOOR PREPARATION: Depending on the sub floor condition, a mechanical treatment may be necessary to meet industry standards. Dust, paint, residual adhesives or other surface materials must be removed prior to installation. It is recommended that the sub floor be cleaned with a vacuum and all cracks and gaps be filled with a Portland based cementitious patch with the exception of expansion joints. Levelness must be 3/16" in a 10' radius or 1/8" in a 6' radius. Radiant heated sub floors must be primed with Hallmark 1 Primer.

INSTALLATION PROCEDURE: Spread the adhesive with the appropriate notched trowel at a 60° angle in order to avoid excessive adhesive thickness. Observe the appropriate flash time. Lay the flooring into the bed of adhesive and press down firmly into place. Roll flooring approximately 15-30 minutes after installation with a 100 lb. roller. Push down raised edges 30-60 minutes after installation.

LIMITATIONS: When using non-Hallmark Floors products in conjunction with Hallmark primers, sealers, or adhesives, Hallmark Floors denies any and all responsibility for any problems and/or damages without prior written approval from Hallmark Floors. In case of accident, injury, spill or exposure, see SDS sheet for information.

While Hallmark Standard 4 Adhesive can withstand up to 5#/24 hrs./1,000 SF (Calcium Chloride Test) of moisture, it does not qualify as a moisture inhibitor. If a moisture inhibitor is required, Hallmark recommends the used of Hallmark 1 Primer (up to 8#/24 hrs./1,000 sf (Calcium Chloride Test and 85% RH), when applied with #22 trowel and maximum coverage of 80 sq. ft. per gallon.

FEATURES: LEED qualified, Contains no solvents , Contains no VOC, nonflammable Ozone friendly , PVA-dispersion base cleans with water.

BENEFITS: Long open time , Spreads easily (higher temp will shorten drying time) No risk of sensitization Spreads easily Very low odor.

LONG TERM FEATURES: Resistant against aging, No health hazards.

APPROVED FLOORING: Hallmark Floors luxury vinyl collections. Town & Country, Castle & Cottage, El Dorado, Sierra Madre, Hermosa Stone, and Times Square.

NOTE ON HALLMARK FLOORS PRODUCTS WITH EZ LOC (LOCKING SYSTEM):

San Simeon Luxury Vinyl Plank

Polaris Premium Vinyl Plank

Courtier Premium Vinyl Plank

These products will stick to Hallmark 3 and 4. Glue down of these Hallmark Floors collections is possible. However, installation is very challenging and time consuming. Proceed at your own discretion. No claims will be honored for additional time required to glue down EZ Loc Collections.

For glue down applications of EZ Loc, follow all directions in EZ Loc installation instructions (separate instruction booklet). Disposable vinyl gloves are very helpful in keeping adhesive off of hands and plank surfaces. Clean up all glue residue from surface of plank as job proceeds.

APPROVED SUB FLOORS:

Concrete (must be clean, dry, and flat).

Concrete - cutback mastic stain (well bonded, negative for asbestos).

OSB (underlayment grade) see Hallmark Floors installation instructions. (requires Baltic Birch on top, filled and sanded).

Plywood (underlayment grade) see Hallmark Floors installation instructions (requires Baltic Birch on top, filled and sanded).

Dried leveling compounds, structurally sound and suitable for use as glue down surface.

NOTE: Hallmark will stick to both OSB and plywood. However, both sub floors will move and the texture of their surfaces will telegraph through the floor. This is not considered a manufacturing defect, and is not covered under Hallmark Floors warranty.

FLASH TIME:

Wet Lay: 10-20 min at 70°F (21°C)

OPEN TIME:

Wet Lay: 20 –40 min at 70°F (21°C)

APPROVED PRIMERS/SEALERS: Hallmark 1 Primer (not suitable for installation over Hallmark 2 Sealer)

APPROVED TROWELS: #1 Trowel: 1/16" x 1/16" x 1/16" (up to 250 sf/gal)

DRYING TIME: Approx. 24 hours

CLEAN UP: Soap and water

PH VALUE: Below 12.4

STORAGE: Above 32°F, not freeze/thaw stable

SHELF LIFE: 12 months in original, unopened pail

CURE TIME UNTIL NORMAL TRAFFIC: approximately 24 hrs.

CLEAN UP: soap and water

TEMPERATURE RANGE DURING INSTALLATION: 50°–90°F

RELATIVE HUMIDITY RANGE DURING INSTALLATION: 30%-80%

COLOR: Cream

STORAGE: Above 32°F, not freeze/thaw stable



V1 2016

2360 S. Archibald Ave.
Ontario, CA 91761

p 888.551.0888

p 909.947.7736

f 909.947.7776

www.hallmarkfloors.com